

The screenshot shows the Scopus Preview interface for the journal 'Asian Pacific Journal of Reproduction'. The page includes the Scopus logo, navigation links for 'Author Search', 'Sources', 'Create account', and 'Sign in'. The main content area displays the journal title, 'Open Access' status, 'Scopus coverage years: from 2012 to Present', 'Publisher: Wolters Kluwer Health', and 'ISSN: 2305-0500 E-ISSN: 2305-0519'. The 'Subject area' is categorized into 'Veterinary: General Veterinary', 'Agricultural and Biological Sciences: Animal Science and Zoology', 'Agricultural and Biological Sciences: Plant Science', 'Medicine: Obstetrics and Gynecology', and 'Medicine: Reproductive Medicine'. The 'Source type' is listed as 'Journal'. On the right side, there are three performance metrics: 'CiteScore 2021' with a value of 2.9, 'SJR 2021' with a value of 0.209, and 'SNIP 2021' with a value of 0.648. At the bottom of the page, there are links for 'View all documents >', 'Set document alert', 'Save to source list', and 'Source Homepage'. The footer contains 'CiteScore', 'CiteScore rank & trend', and 'Scopus content coverage'.

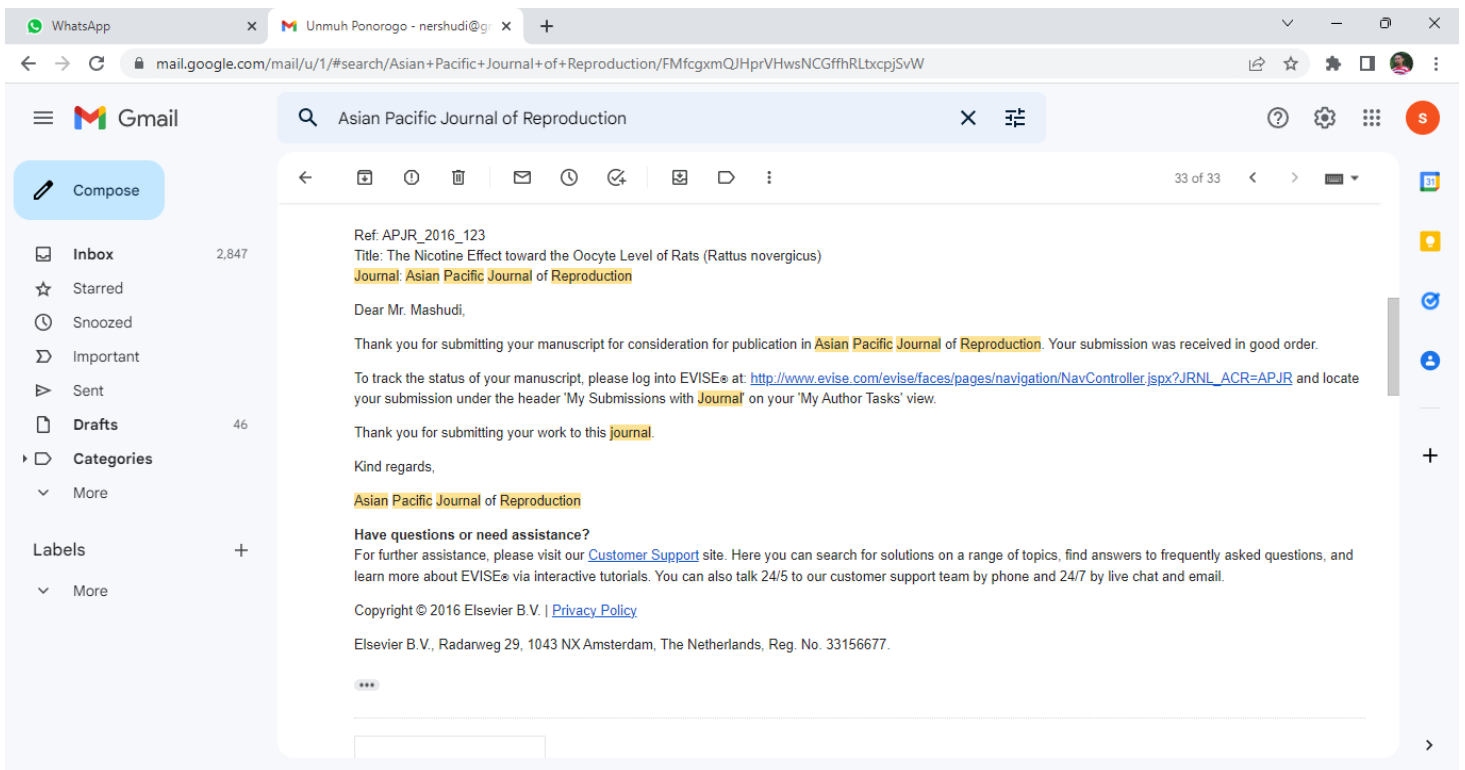
<https://www.scopus.com/sourceid/21100389723>

### **BUKTI KORESPONDENSI**

- 1. Submite Artikel ke Asian Pacific Journal of reproduction  
21 Juli 2016**
- 2. Revisi I dari Asian Pacific Journal of reproduction  
14 Oktober 2016**
- 3. Mendapatkan LOA dari Asian Pacific Journal of reproduction  
20 Oktober 2016**
- 4. Revisi Final dari Asian Pacific Journal of reproduction  
25 Oktober 2016**
- 5. Accepted for Publication dari Asian Pacific Journal of reproduction  
25 Oktober 2016**
- 6. Editor Proofreading dari Asian Pacific Journal of reproduction  
17 November 2016**
- 7. Online Publication Complete dari Asian Pacific Journal of reproduction  
30 November 2016**
- 8. Published Online dari Asian Pacific Journal of reproduction  
10 Desember 2016**

# 1. Submite Artikel ke Asian Pacific Journal of reproduction

## 21 Juli 2016



The screenshot shows a Gmail interface with a search bar containing "Asian Pacific Journal of Reproduction". The email content is as follows:

Ref: APJR\_2016\_123  
Title: The Nicotine Effect toward the Oocyte Level of Rats (*Rattus novergicus*)  
Journal: [Asian Pacific Journal of Reproduction](#)

Dear Mr. Mashudi,

Thank you for submitting your manuscript for consideration for publication in [Asian Pacific Journal of Reproduction](#). Your submission was received in good order.

To track the status of your manuscript, please log into EVISE® at: [http://www.evise.com/evise/faces/pages/navigation/NavController.jspx?JRNL\\_ACR=APJR](http://www.evise.com/evise/faces/pages/navigation/NavController.jspx?JRNL_ACR=APJR) and locate your submission under the header 'My Submissions with [Journal](#)' on your 'My Author Tasks' view.

Thank you for submitting your work to this [journal](#).

Kind regards,  
[Asian Pacific Journal of Reproduction](#)

**Have questions or need assistance?**  
For further assistance, please visit our [Customer Support](#) site. Here you can search for solutions on a range of topics, find answers to frequently asked questions, and learn more about EVISE® via interactive tutorials. You can also talk 24/5 to our customer support team by phone and 24/7 by live chat and email.

Copyright © 2016 Elsevier B.V. | [Privacy Policy](#)  
Elsevier B.V., Radarweg 29, 1043 NX Amsterdam, The Netherlands, Reg. No. 33156677.

# **The Nicotine Effect toward the Oocyte Level of Rats (*Rattus novergicus*)**

**Running title: The Nicotine Effect toward the Oocyt**

**Yayuk Dwirahayu<sup>1</sup>, Sugeng Mashudi<sup>2\*</sup>**

<sup>1</sup>Department of Nursing, Faculty of Health Sciences, Muhammadiyah University of Ponorogo, Ponorogo, East Java, Indonesia

<sup>2</sup>Department of Midwifery, Faculty of Health Sciences, Muhammadiyah University of Ponorogo, Ponorogo, East Java, Indonesia

Corresponding author's mailing address: nershudi@gmail.com

## **Abstract**

Nicotine is a component of cigarette. Smoking cigarettes can increase infertility because it blocks oocyte's maturity, decrease the ability of ovulation and fertility, and increase diploid oocyte possibility. This research was aimed to discover the effect of some nicotine's doses to the maturity of rat's oocyte in reproductive age. This study was using an experimental design with 3 treatment groups (subcutaneous injection of nicotine 35, 52.5 and 70 mg/kgBW/day for 7 days) and 1 control group. After nicotine exposure treatment, the oocytes of rats were taken for the histological purpose to observe the oocyte's maturity grade in Germinal Vesicle (GV), Germinal Vesicle Breakdown (GVBD), Metaphase I (M I), or Metaphase II (M II). All of the oocytes were stained using Aceto Orcein 1 %. The data was analyzed based on One-Way Analysis of Variance (ANOVA) ( $\alpha = 0.05$ ). The significant result got further analyzed using LSD test. The result obtained that there were no significant differences of GV and GVBD oocytes in all groups. Otherwise, the result of One-Way ANOVA showed that there was significant differences of M-II oocytes in all groups. LSD test obtained that there was significant differences between control group and 3 treatment groups, and nicotine's treatment 52,5 mg/kgBW with 35 mg/kgBW. This research obtained that the number of GV and GVBD oocytes were lower than the control group. Also, there was no M I and M II oocytes because of nicotine treatment were less than the control group.

Keywords: germinal vesicle, germinal vesicle breakdown, metaphase I, metaphase II, nicotine

## 1. Introduction

Nicotine is one of the components in a cigarette that considered as addiction substance that cause smoking habit. Infertility is a determination of the existence and cause of death of the products of conception or fertility disorders. Compounds that contained in cigarette smoke consist of 90 % gas and 20 % different kinds of particles. The gaseous substance in a cigarette is CO, CO<sub>2</sub>, cyanide, various hydrocarbons, and organic acids.<sup>[1]</sup> Women who smoke affect their reproductive system because every cigarette contains 4,000 chemicals. Chemicals particles in a cigarette are divided into 3 groups: nicotine, tar, and carbon monoxide. One of the impacts on women's reproduction is infertility.<sup>[1]</sup>

Some researches that have been conducted shows that the pair of men and women who are infertile after consuming cigarettes for more than 5 years. The cigarettes that are consumed contain 0.8 - 1.8 mg nicotine per cigarette; but it depends on the brand and size. One mg of nicotine can be absorbed into the body during smoking one cigarette.<sup>[2]</sup> The same point was described by Augood (2008), he stated that the risk of infertility of active smoker women is 1.6 times more than non-smoker women.<sup>[3]</sup>

Research about cigarettes that have been conducted indicates the concentration of cotinine (nicotine metabolic compounds) got in follicular fluid, which can affect the maturation of oocytes for *in vitro* fertilization.<sup>[4]</sup> The assumption is proved by the presence of oocyte maturation reduction up to 50 % in women over 40 years.<sup>[4]</sup> Other study conducted to hamsters that are treated with nicotine exposure for 7 days can interrupt folliculogenesis process.<sup>[5]</sup> The folliculogenesis will be issued oocyte, so it is assumed that the duration of nicotine exposure for 7 days will affect oocyte maturation process. The research of Mailhess et al. (2000) toward mice by providing nicotine subcutaneous injection with dosage 5, 7.5, and 10 mg/kg have been able to influence the meiosis of oocytes by the acquisition of oocyte aneuploidy.<sup>[6]</sup> Based on Mailhess *et al* (2000), the dosage of nicotine exposure of this study was set into 35, 52.5, and 70 mg/kg.<sup>[6]</sup> That dosage came from Mailhess *et al.* (2000) toward mice dosage then converted to rats dosage by multiplied it with 7.0.<sup>[6,7]</sup>

The process of meiosis in oocytes is influenced by endogenous and exogenous factors through biochemical reactions during oocyte maturation.<sup>[6]</sup> Exogenous factor that is considerably influenced is the cigarettes, the largest of its component is nicotine. The differences between nicotine effects on oocyte maturation at age less than 40 years old and over 40 years old support this study to determine the effects of nicotine on oocyte maturation with different doses of reproductive age and consideration maturation of important oocyte in the reproductive age.

## 2. Materials and Methods

This research was conducted using experimental design by providing a treatment in mice given a subcutaneous injection of nicotine with a dosage of 35, 52.5, and 70 mg/kg per day. The type of design used was a post-test only control group design with a schematic design of the study (Fig. 1).

A sample of 36 rats (*Rattus norvegicus*) was divided into a control group, P1, P2 and P3. Independent variable was nicotine dosage, while the dependent variables were the level of Germinal Vesicle (GV), Germinal Vesicle Breakdown (GVBD), Metaphase I (M I), or Metaphase II (M II). After nicotine exposure treatment, the oocytes of rats were taken for the histological purpose to observe the oocyte's maturity grade in GV, GVBD, M I or M II. All of the oocytes were stained using Aceto Orcein 1 %. The data was analyzed based on One-Way Analysis of Variance (ANOVA) ( $\alpha = 0.05$ ). GV and GVBD oocyte was tested using Kruskal-Wallis comparison test because the data were not normally distributed, meanwhile, the data of M II oocyte were normally distributed. Otherwise, M I data could not be analyzed because it has zero data. The significant result got further analyzed using LSD test.

## 3. Results

This study provided nicotine exposure in rats (*Rattus novergicus*). The group consisted of negative control treatment (P0) for the control group (K0) as the comparison result, P1 (nicotine 35 mg/kg) for K1, P2 (52.5 mg/kg) for K2, and P3 (70 mg/kg) for K3 (Fig. 2 – Fig. 6).

Figure 2 shows that the greater the dose of nicotine makes the more increasing number of GV. It shows the number of immature oocytes is also increased. Figure 3 shows that GVBD does not describe a similar pattern to GV. K0 and K1 show the same results but K2 and K3 do not produce data GVBD. Based on Figure 4 shows that that is not found oocytes was in the phase of M I. Figure 5 shows that the greater the nicotine dose given to the rats makes the less number of M II oocytes produced. This illustrates that the decrease of mature oocytes due to nicotine exposure. The description of oocytes at different maturation levels obtained in this study can be seen in Figure 6. The level of maturation that found only GV, GVBD, and M II.

Oocytes amount in M II maturity is followed by BNT test to determine a treatment group was significantly different. Table 1 shows the results of BNT test (Appendix 5), showing the differences in all groups except between P2 and P3.

#### 4. Discussion

This study used 36 rats (*Rattus norvegicus*) as an experimental animal, then are divided into a control group, P1, P2 and P3. The observed result is the rate of maturation of GV, GVBD, M I and M II. Maturation level observation of GV and GVBD based on Kruskal-Wallis test shows there was no significant difference between the treatment groups.

Oocytes maturity after GV is GVBD. The oocyte maturation process, GVBD phase, is begun because there is a response to hormone stimulus which is started by the outbreak of the core wall or GVBD. With the onset of GVBD, chromosomes condense into a compact form. The centrosome (a special area in the form of cytoplasm that solidifies) divide the two centrioles that look like cylinder shape. This cylinder shape is moving apart and form the spindle for cell proliferation purpose.<sup>[8]</sup>

These nonstandard results probably caused by the deviation standard of data that was too wide and less specific, therefore, the small difference between the data will not create a significant difference. The SD value in this study was high as a consequence of trouble shooting during research method. Not all rats ovum were taken for the histopathological observation that caused the data varies from zero to the highest number of ova which was made the data has high SD value.

These results indicated that the impact of nicotine exposure toward oocyte maturation has not been able to suppress the level of GV/GVBD. The factors that might be influenced were the number of experimental animals, the dose, and duration of nicotine exposure. In this study, the limited rats number used as the experimental animal has a weakness, if ovum were unavailable in one rat (zero) it would affect the whole data. Therefore, further studies are needed more rats number for better data obtained.

The nicotine exposure dosage determination was based on the study conducted by Mailhess et al. (2000) which provides exposure to nicotine in mice oocytes.<sup>[6]</sup> Furthermore, the nicotine mice dosage was had been converted to rats dose. The previous study observed the 4<sup>th</sup> level of maturation, while Mailhess et al. (2000) observed the meiosis process occurred in ovum at M II phase.<sup>[6]</sup>

In this study GV and GVB were not significantly different, it was supported by a similar study conducted by Zenzes and Bielecki (2004) that also provides nicotine exposure toward mice ovum.<sup>[4]</sup> The results prove that nicotine does not affect the level of maturation to GV/GVBD, but induce abnormal spindle and chromosomes of the oocyte maturation process. The exposure duration used in this study was 7 days that according to research conducted by

of Bordel *et al.* (2006), which performed nicotine exposure for 7 days toward hamsters to observe folliculogenesis.<sup>[5]</sup> The previous studies were similar but they have different research purposes that make result obtained on GV and GVBD were different significantly.

The process of maturation after GV and GVBD is M I. This study obtained that all M I data were zero, indicated that there were not metaphase I process in all experimental animals. That was probably caused by a rapid process for M I before it turned into M II process and its growth stalled in the secondary oocyte.<sup>[9]</sup> M I arose after GVBD process, where the nuclear membrane was folded and pores disappeared. The rest of the nuclear membrane disappeared quickly. Nuclei also disappear quickly after it contacts with the cytoplasm.<sup>[9]</sup> M I was not found in this study, the same result was also obtained by Mailhess, *et al.* (2000) who examined the ovum maturation as a result of nicotine exposure found out that all ovum were had already being in the M II process.<sup>[6]</sup> The rapid change of GVBD to M II is allegedly being a reason for the absence of M I in this study.

The last phase is the M II that occurred after the M I. The One-Way ANOVA test result obtained that there were significant differences among all groups. This shows that nicotine affects the maturation of the ovum by reducing the number of M II in nicotine -exposed rats. The little number of M II oocytes indicated that the number of mature oocytes was insignificant due to the number of M II oocytes show that they were already mature. Oocytes which have been developed that are already mature when they were taken from the follicle will have complete meiosis process after reaching metaphase II.<sup>[10]</sup> The mature oocytes number of nicotine-exposed rats group is low because of increased nicotine exposure is associated with estradiol reduction that followed by a decrease of ovarian stimulation and the number of oocytes.<sup>[11]</sup>

Nicotine is an oxide compound that can increase oxidative stress in the body. Oxidative stress that occurs in follicular fluid thus causing follicular granulosa cell apoptosis and disrupt the folliculogenesis process makes the follicles shrink.<sup>[5,12]</sup> The size of the follicle affects the development of oocyte. Mailhess *et al.*, (2000) mentioned that nicotine can affect oocyte maturation process.<sup>[6]</sup> Furthermore, the oocyte ability to complete meiosis and maturation depends on the size of the follicle. The number of mature oocytes from small follicles less than mature oocytes from large follicles, thus the presence of nicotine decrease the number of mature oocytes because it affected the follicles size.<sup>[13,14]</sup>

The BNT test result shows that there was a significant difference between the control group and the treatment group. This means the group which was not treated with nicotine produced mature oocytes. Otherwise, the group treated with nicotine in any dose will inhibit

oocyte maturation. The dosage differences showed that only doses in groups P2 and P3 that were not significantly different, but others groups were significantly different. This indicated that low dosage of nicotine (35 mg/kg body weight) can disturb the maturation of rats ovum, the same result was obtained by other higher dosages. Otherwise, the intermediate dose (52.5 mg/kg) and high dose (70 mg/kg) obtained they were not significantly different toward oocyte process disruption. It indicated that intermediate and high doses performed the same effect in this study. The dose that may be decreased the number of M II in this study was started from 35 mg/kg body weight of rats (*Rattus novergicus*).

The converting dose from rats to human is multiplied by 56.0.<sup>[7]</sup> The nicotine dose that assumed to reduce human oocytes during M II process is 1.960 mg or 1.96 grams. During smoking, the human body can absorb nicotine ranged from 1-1.5 mg, thus it is assumed that mature oocytes of women will significantly decrease after exposed for about 1960 cigarettes, either the woman is an active or passive smoker. The number of cigarettes is still influenced by the volume of cigarettes, inhaled smoke, surround air condition, and the intensity of smoking.<sup>[15]</sup>

## **5. Conclusion**

Nicotine exposure doses from 35, 52.5, and 70 mg/kg did not affect the maturation of oocytes process either at GV stage nor GVBD. M I oocytes phase was not found in this study (zero). Nicotine exposure in all doses could decrease the number of oocytes at M II phase. Furthermore, there is needed further research which can conduct a larger number of dose and exposure duration to obtain the better results.

## **6. Acknowledgement**

The author thank to Muhammadiyah University of Ponorogo for supporting this project.

## **7. Funding Sources**

This research did not receive any specific grant from funding agencies in the public, commercial, or not-for-profit sectors.

## **8. References**

1. Schardein JL. Chemically Induced Birth Defect. Marcel Dekker Inc. New York 2005. pp 764-768.



2. Klonoff-Cohen H, Natarajan L, Marrs R, Yee B. Effect of female and male smoking on succes rates of IVF and gamete intra fallopian transfer. *Hum Reprod* 2001; 16(7): 1382-1390.
3. Augood C, Duckitt K, Templeton AA. Smoking and female infertility: A systematic review and meta analysis. *Hum Reprod* 1998; 13(6): 1532-1539.
4. Zenzes MT, Bielecki R. Nicotine-induced disturbances of meiotic maturation in cultured mouse oocytes: alterations of spindle integrity and chromosome alignment. *Tob Induc Dis* 2004; 2(3): 151-161. doi: 10.1186/1617-9625-2-3-151.
5. Bordel R, Laschke MW, Menger MD, Volmar B. Nicotine does not effect vascularization but inhibit growth of freely transplanted ovarian follicles by inducing granulosa cell apoptosis. *Hum Reprod* 2006; 21(3): 610-616. doi: 10.1093/humrep/dei393.
6. Mailhes J, Young D, Caldito G, London SN. Sensitivity of mouse oocytes to nicotine-induced perturbations during oocyte meiotic maturation and aneuploidy in vivo and in vitro. *Mol Hum Reprod* 2000; 6(3): 232-237.
7. Kusumawati D. Pengaruh Pemberian Stevoisida terhadap Reproduksi dan Perkembangan Embrio Tikus Putih. PhD Thesis. Airlangga University. Surabaya 2003.
8. Greenstein D. Control of oocyte meiotic maturation and fertilization. *Wormbook*. Nashville 2005. pp 1-12.
9. Centola GM, Anderson LD, Channing CP. Oocyte maturation inhibitor (OMI) activity in protein granulosa cells. *Gamet Res* 2005; 4(5): 451-461. doi: 10.1002/mrd.1120040508.
10. Mrazek M, Fulka Jr J. Failure of oocyte maturation: possible mechanisms for oocyte maturation arrest. *Hum Reprod* 2003; 18(11): 2249-2252. doi: 10.1093/humrep/deg434.
11. El-Nemr A, Al-Shawaf T, Sabatini L, Wilson C, Lower AM, Grudzinskas JG. Effect of smoking on ovarian reserve and ovarian stimulation in in-vitro fertilization and embryo transfer. *Hum Reprod* 1998; 13(8): 2192-2198.
12. Paszkowski T, Clarke RN, Hornstein MD. Smoking induces oxidative stress inside the graafian follicle. *Hum Reprod* 2002; 17(4): 921-925.
13. Son W-Y, Lee S-Y, Lim J-H. Fertilization, cleavage and blastocyst development according to the maturation timing of oocytes in invitro maturation cycles. *Hum Reprod* 2005; 20(11): 3204-3207. doi: 10.1093/humrep/dei95.

14. Lim JH, West KL, Pubinstein Y, Bergel M, Postnikov YV, Bustin M. Chromosomal protein HMGN1 enhances the acetylation of lysine 14 in histone H3. *EMBO J* 2005; 24(7): 3038-3048. doi: 10.1038/sj.emboj.7600768.
15. Hukkanen J, Jacob P 3rd, Benowitz NL. Metabolism and disposition kinetics of nicotine. *Pharmacol Rev* 2005; 57(1): 79-115. doi: 10.1124/pr.57.1.3.

## 9. Tables

Table 1. The further test results of BNT in the maturation of M II

Group	Test of BNT P	Note
Control-P1	0,000	Significant different
Control-P2	0,000	Significant different
Control-P3	0,000	Significant different
P1-P2	0,046	Significant different
P1-P3	0,002	Significant different
P2-P3	0,177	No significant different

## 10. Figures and Figure Legends

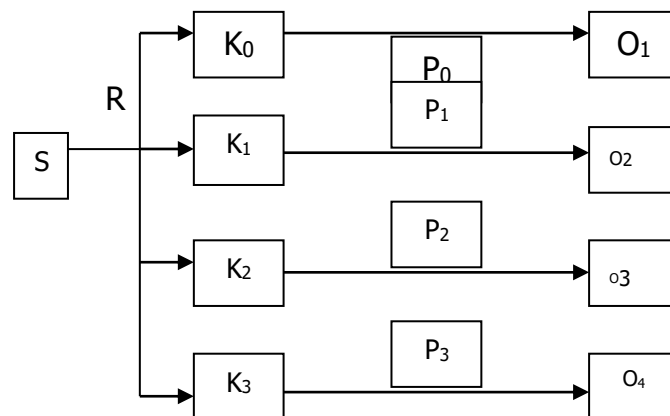


Figure 1. Research Plan Flowchart

Note:

S : Sample

R : Random

K<sub>0</sub> : The control group

K<sub>1</sub> – K<sub>3</sub>: The treatment group

P<sub>0</sub> : Given nicotine using aquabidest for 7 days

Given nicotine distilled water for 7 days

P<sub>1</sub> : Given nicotine 35 mg/Kg BB for 7 days

P<sub>2</sub> : Given nicotine 52,5 mg/Kg BB for 7 days

P<sub>3</sub> : Given nicotine 70 mg/kg BB for 7 days

O<sub>1</sub> – O<sub>4</sub>: the observation result (the number of oocytes GV, GVBD, M I, and M II)

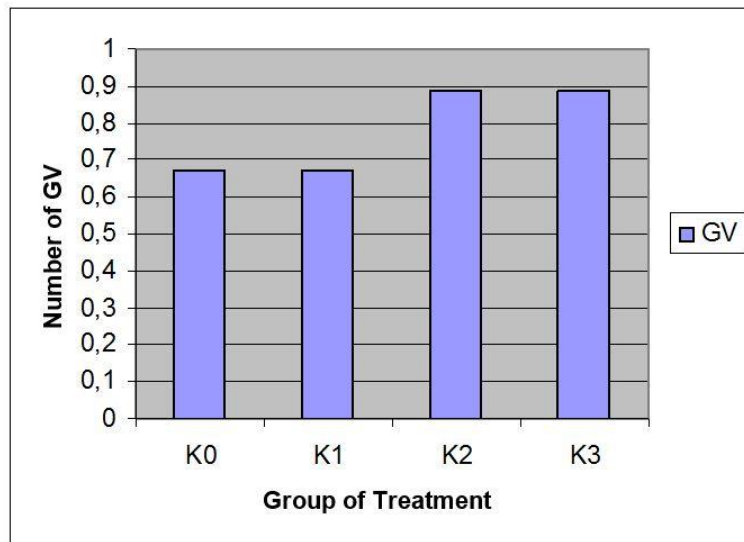


Figure 2. The number of GV in various groups

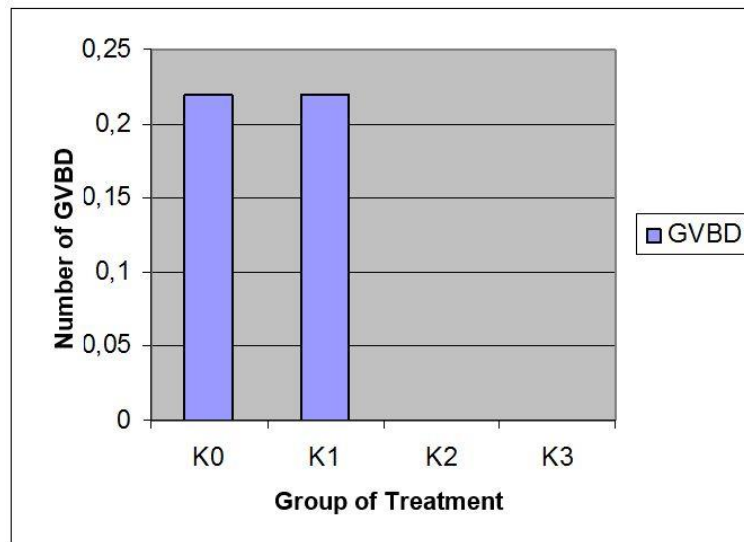


Figure 3. The number of GVBD on different groups

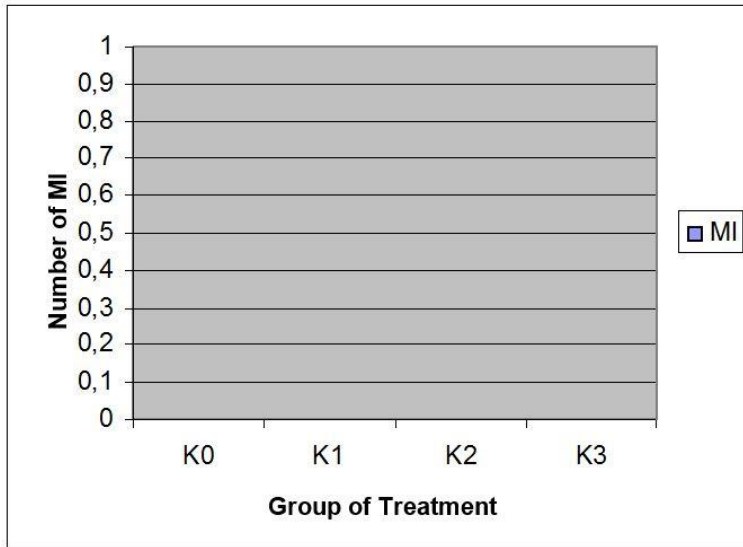


Figure 4. The number of M I in various groups

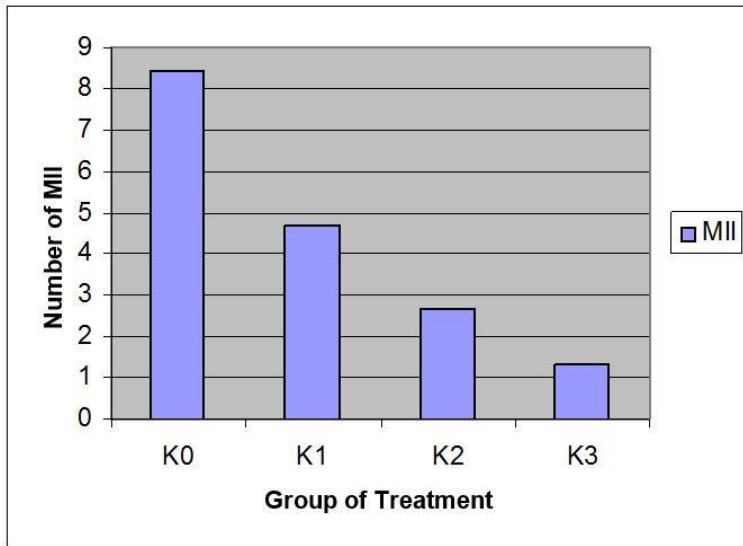


Figure 5. The number of M II in the various groups

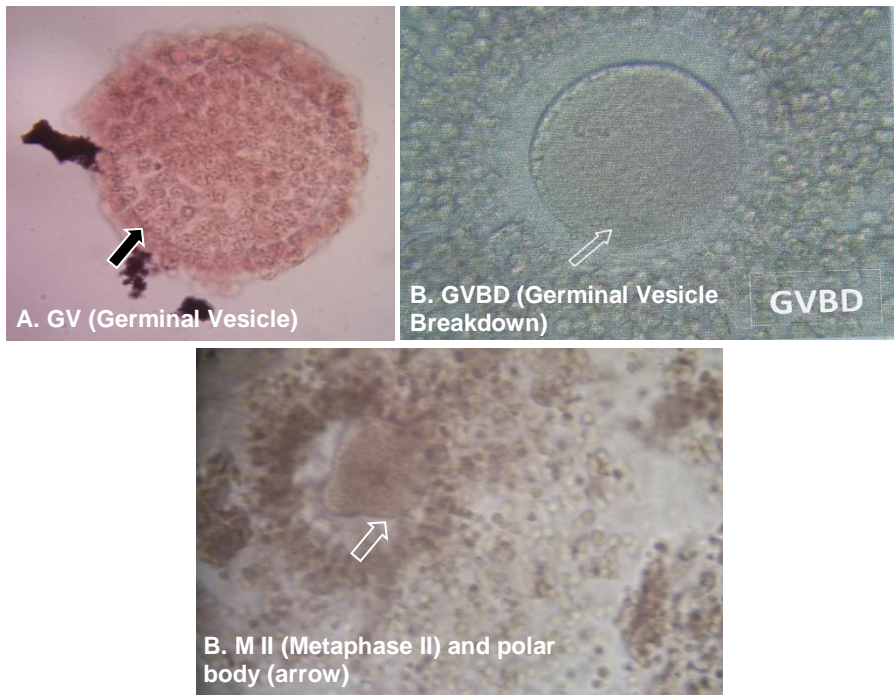
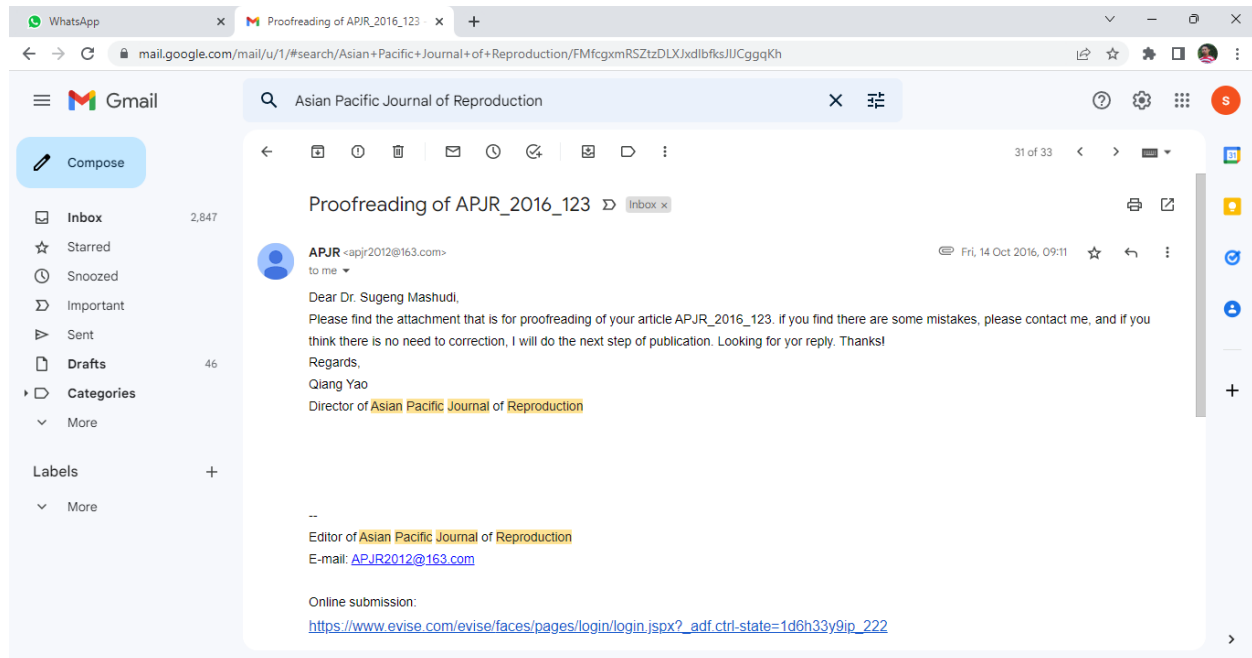


Figure 6. Different level of maturation of oocytes

## 2. Revisi I dari Asian Pacific Journal of reproduction 14 Oktober 2016



**Title:** Nicotine effect toward the oocyte level of rats (*Rattus novergicus*)

**Author:**

YayukDwiraHayu<sup>1</sup>, Sugeng Mashudi<sup>2\*</sup>

**Affiliations:**

<sup>1</sup>Department of Nursing, Faculty of Health Sciences, Muhammadiyah University of Ponorogo, Ponorogo, East Java, Indonesia

<sup>2</sup>Department of Midwifery, Faculty of Health Sciences, Muhammadiyah University of Ponorogo, Ponorogo, East Java, Indonesia

\*Corresponding author: Sugeng Mashudi\*, Department of Midwifery, Faculty of Health Sciences, Muhammadiyah University of Ponorogo, Ponorogo, East Java, Indonesia.

E-mail: nershudi@gmail.com

This paper has 6 figures and 0 table.

**Key words:**

Germinal vesicle

Germinal vesicle breakdown

Metaphase I

Metaphase II

Nicotine



## **Abstract**

**Objective:** To discover the effect of some nicotine's doses to the maturity of rat's oocyte in reproductive age.

**Methods:** this study was using an experimental design with 3 treatment groups (subcutaneous injection of nicotine 35, 52.5 and 70 mg/kgBW/d for 7 d) and 1 control group. After nicotine exposure treatment, the oocytes of rats were taken for the histological purpose to observe the oocyte's maturity grade in germinal vesicle (GV), Germinal Vesicle Breakdown (GVBD), Metaphase I (M I), or Metaphase II (M II). All of the oocytes were stained using Aceto orcein 1 %. The data was analyzed based on One-Way Analysis of Variance ( $\alpha = 0.05$ ).

**Results:** The significant result got further analyzed using LSD test. The result obtained that there were no significant differences of GV and GVBD oocytes in all groups. Otherwise, the result of One-Way ANOVA showed that there was significant differences of M-II oocytes in all groups. LSD test obtained that there was significant differences between control group and 3 treatment groups, and nicotine's treatment 52,5 mg/kg body weight (BW) with 35 mg/kg BW. This research obtained that the number of GV and GVBD oocytes were lower than the control group. **Conclusion:** there was no M I and M II oocytes, because nicotine treatment were less than the control group.

## 1. Introduction

Nicotine is one of the components in a cigarette that considered as addiction substance that cause smoking habit. Infertility is a determination of the existence and cause of death of the products of conception or fertility disorders. Compounds that contained in cigarette smoke consist of 90% gas and 20% different kinds of particles. The gaseous substance in a cigarette is CO, CO<sub>2</sub>, cyanide, various hydrocarbons, and organic acids [1]. Women who smoke, their reproductive system will be affected, because every cigarette contains 4 000 chemicals. Chemicals particles in a cigarette are divided into 3 groups: nicotine, tar, and carbon monoxide. One of the impacts on women's reproduction is infertility [1].

Some researches that have been conducted shows that the pair of men and women who are infertile after consuming cigarettes for more than 5 years. The cigarettes that are consumed contain 0.8–1.8 mg nicotine per cigarette; but it depends on the brand and size. One milligram of nicotine can be absorbed into the body during smoking one cigarette [2]. The same point was described by Mai, *et al.* [3], he stated that the risk of infertility of active smoker women is 1.6 times more than non-smoker women [3].

Research about cigarettes that have been conducted indicates the concentration of cotinine (nicotine metabolic compounds) got in follicular fluid, which can affect the maturation of oocytes for *in vitro* fertilization [4]. The assumption is proved by the presence of oocyte maturation reduction up to 50% in women over 40 years [4]. Other study conducted to hamsters that are treated with nicotine exposure for 7 d whose folliculogenesis process can be interrupted [5]. The folliculogenesis will be issued oocyte, so it is assumed that the duration of nicotine exposure for 7 d will affect oocyte maturation process. The research of Noor, *et al.* [6] toward mice by providing nicotine subcutaneous injection with dosage 5, 7.5, and 10 mg/kg have been able to influence the meiosis of oocytes by the acquisition of oocyte aneuploidy [6]. Based on Mailhess, *et al.* (2000), the dosage of nicotine exposure of this study was set into 35, 52.5, and 70 mg/kg [6]. That dosage came from Noor, *et al.* [6] toward mice dosage then converted to rats dosage by multiplied it with 7.0 [6,7].

The process of meiosis in oocytes is influenced by endogenous and exogenous factors through biochemical reactions during oocyte maturation [6]. Exogenous factor that is considerably influenced is the cigarettes, the largest of its component is nicotine. The differences between nicotine effects on oocyte maturation at age less than 40 years old and over 40 years old support this study to determine the effects of nicotine on oocyte maturation with

different doses of reproductive age and consideration maturation of important oocyte in the reproductive age.

## 2. Materials and methods

This research was conducted using experimental design by providing a treatment in mice given a subcutaneous injection of nicotine with a dosage of 35, 52.5, and 70 mg/kg per day. The type of design used was a post-test only control group design with a schematic design of the study (Figure 1).

A sample of 36 rats (*Rattus norvegicus*) was divided into a control group, P1, P2 and P3. Independent variable was nicotine dosage, while the dependent variables were the level of germinal vesicle (GV), germinal vesicle breakdown (GVBD), metaphase I (M I), or metaphase II (M II). After nicotine exposure treatment, the oocytes of rats were taken for the histological purpose to observe the oocyte's maturity grade in GV, GVBD, M I and M II. All of the oocytes were stained using Aceto orcein 1%. The data was analyzed based on One-Way Analysis of Variance (ANOVA) ( $\alpha=0.05$ ). GV and GVBD oocyte was tested using Kruskal-Wallis comparison test because the data were not normally distributed, meanwhile, the data of M II oocyte were normally distributed. Otherwise, M I data could not be analyzed because it has zero data. The significant result got further analyzed using LSD test.

## 3. Results

This study provided nicotine exposure in rats (*Rattus novergicus*). The group consisted of negative control treatment (P0) for the control group (K0) as the comparison result, P1 (nicotine 35 mg/kg) for K1, P2 (52.5 mg/kg) for K2, and P3 (70 mg/kg) for K3 (Figure 2–Figure 6).

Figure 2 shows that the greater the dose of nicotine makes the increasing number of GV. It shows the number of immature oocytes is also increased. Figure 3 shows that GVBD does not describe a similar pattern to GV. K0 and K1 show the same results but K2 and K3 do not produce data GVBD. Figure 4 shows that there is not found oocytes in the phase of M I. Figure 5 shows that the greater the nicotine dose given to the rats, the less number of M II oocytes produced. This illustrates that the decrease of mature oocytes due to nicotine exposure. The

description of oocytes at different maturation levels obtained in this study can be seen in Figure 6. The level of maturation that found only GV, GVBD, and M II.

Oocytes amount in M II maturity is followed by BNT test to determine a treatment group was significantly different. BNT test of the maturation of M II showed that comparison of all groups are significant different, except between P2 and P3.

#### 4. Discussion

Oocytes maturity after GV is GVBD. The oocyte maturation process, GVBD phase, is begun because there is a response to hormone stimulus which is started by the outbreak of the core wall or GVBD. With the onset of GVBD, chromosomes condense into a compact form. The centrosome (a special area in the form of cytoplasm that solidifies) divide the two centrioles that look like cylinder shape. This cylinder shape is moving apart and form the spindle for cell proliferation purpose [8].

These nonstandard results probably caused by the deviation standard of data that was too wide and less specific, therefore, the small difference between the data will not create a significant difference. The SD value in this study was high as a consequence of trouble shooting during research method. Not all rats ovum is taken for the histopathological observation that caused the data varies from zero to the highest number of ova which was made the data have high SD value.

These results indicated that the impact of nicotine exposure toward oocyte maturation has not been able to suppress the level of GV/GVBD. The factors that might be influenced were the number of experimental animals, the dose, and duration of nicotine exposure. In this study, the limited rats number used as the experimental animal has a weakness, if ovum were unavailable in one rat (zero) it would affect the whole data. Therefore, further studies are needs more rats number for better data obtained.

The nicotine exposure dosage determination was based on the study conducted by Noor, *et al.* [6] which provides exposure to nicotine in mice oocytes. Furthermore, the nicotine mice dosage was had been converted to rats dose. The previous study observed the 4th level of maturation, while Noor, *et al.* [6] observed the meiosis process occurred in ovum at M II phase.

In this study GV and GVB were not significantly different, and it was supported by a similar study conducted by Jennings, *et al.* [4] that also provides nicotine exposure toward mice ovum. The results prove that nicotine does not affect the level of maturation to GV/GVBD, but induce

abnormal spindle and chromosomes of the oocyte maturation process. The exposure duration used in this study was 7 d that according to research conducted by Bordel, *et al.* [5], which performed nicotine exposure for 7 d toward hamsters to observe folliculogenesis [5]. The previous studies were similar but they have different research purposes that make result obtained on GV and GVBD were different significantly.

The process of maturation after GV and GVBD is M I. This study obtained that all M I data were zero, indicated that there were not metaphase I process in all experimental animals. That was probably caused by a rapid process for M I before it turned into M II process and its growth stalled in the secondary oocyte [9] M I arose after GVBD process, where the nuclear membrane was folded and pores disappeared. The rest of the nuclear membrane disappeared quickly. Nuclei also disappear quickly after it contacts with the cytoplasm [9]. M I was not found in this study, the same result was also obtained by Noor, *et al.* [6] who examined the ovum maturation as a result of nicotine exposure found out that all ovum were had already being in the M II process. The rapid change of GVBD to M II is allegedly being a reason for the absence of M I in this study.

The last phase is the M II that occurred after the M I. The One-Way ANOVA test result obtained that there were significant differences among all groups. This shows that nicotine affects the maturation of the ovum by reducing the number of M II in nicotine-exposed rats. The little number of M II oocytes indicated that the number of mature oocytes was insignificant due to the number of M II oocytes show that they were already mature. Oocytes which have been developed that are already mature when they were taken from the follicle will have complete meiosis process after reaching metaphase II [10]. The mature oocytes number of nicotine-exposed rats group is low because of increased nicotine exposure is associated with estradiol reduction that followed by a decrease of ovarian stimulation and the number of oocytes [11].

Nicotine is an oxide compound that can increase oxidative stress in the body. Oxidative stress that occurs in follicular fluid thus causing follicular granulosa cell apoptosis and disrupt the folliculogenesis process makes the follicles shrink [5,12]. The size of the follicle affects the development of oocyte. Noor, *et al.*, [6] mentioned that nicotine can affect oocyte maturation process. Furthermore, the oocyte ability to complete meiosis and maturation depends on the size of the follicle. The number of mature oocytes from small follicles less than mature oocytes from large follicles, thus the presence of nicotine decrease the number of mature oocytes because it affected the follicles size [13,14].

The BNT test result shows that there was a significant difference between the control group and the treatment group. This means the group which was not treated with nicotine produced mature oocytes. Otherwise, the group treated with nicotine in any dose will inhibit oocyte maturation. The dosage differences showed that only doses in groups P2 and P3 that were not significantly different, but other groups were significantly different. This indicated that low dosage of nicotine (35 mg/kg body weight) can disturb the maturation of rats ovum, the same result was obtained by other higher dosages. Otherwise, the intermediate dose (52.5 mg/kg) and high dose (70 mg/kg) obtained they were not significantly different toward oocyte process disruption. It indicated that intermediate and high doses performed the same effect in this study. The dose that may be decreased the number of M II in this study was started from 35 mg/kg body weight of rats (*Rattus novergicus*).

The converting dose from rats to human is multiplied by 56.0 [7]. The nicotine dose that assumed to reduce human oocytes during M II process is 1.960 mg or 1.96 grams. During smoking, the human body can absorb nicotine ranged from 11.5 mg, thus it is assumed that mature oocytes of women will significantly decrease after exposed for about 1 960 cigarettes, either the woman is an active or passive smoker. The number of cigarettes is still influenced by the volume of cigarettes, inhaled smoke, surround air condition, and the intensity of smoking [1

We conclude that nicotine exposure doses from 35, 52.5, and 70 mg/kg did not affect the maturation of oocytes process either at GV stage nor GVBD. M I oocytes phase was not found in this study (zero). Nicotine exposure in all doses could decrease the number of oocytes at M II phase. Furthermore, there is needed further research which can conduct a larger number of dose and exposure duration to obtain the better results.

### **Acknowledgement**

The author thank to the Muhammadiyah University of Ponorogo for facilitating this research.

### **Statement of conflict interest**

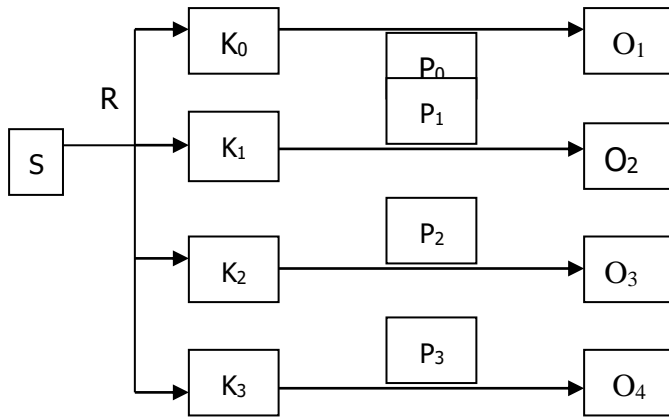
The authors declare that they have no competing interest.

## References

- [1] Schardein JL. Chemically Induced Birth Defect. New York: Marcel Dekker Inc; 2005, p. 764-768.
- [2] Firms S, Cruzat VF, Keane KN, Joesbury KA, Lee AH, Newsholme P, et al. The effect of cigarette smoking, alcohol consumption and fruit and vegetable consumption on IVF outcomes: a review and presentation of original data. *Reprod Biol Endocrinol* 2015; **13**: 134. doi: 10.1186/s12958-015-0133-x.
- [3] Mai Z, Lei M, Yu B, Du H, Liu J. The effects of cigarette smoke extract on ovulation, oocyte morphology and ovarian gene expression in mice. *PloS ONE* 2014; **9**(4): e95945. doi: 10.1371/journal.pone.0095945.
- [4] Jennings PC, Merriman JA, Beckett EL, Hansbro PM, Jones KT. Increased zona pellucida thickness and meiotic spindle disruption in oocytes from cigarette smoking mice. *Hum Reprod* 2011; **0**(0): 1-7. doi: 10.1093/humrep/deq393.
- [5] Bordel R, Laschke MW, Menger MD, Volmar B. Nicotine does not effect vascularization but inhibit growth of freely transplanted ovarian follicles by inducing granulosa cell apoptosis. *Hum Reprod* 2006; **21**(3): 610-616. doi: 10.1093/humrep/dei393.
- [6] Noor MS, Bahkriansyah HM, Widjiati W, Santoso B. Nicotine supplementation blocks oocyte maturation in *Rattus norvegicus*. *Universa Medicina* 2013; **32**(2): 92-98.
- [7] Kusumawati D. Pengaruh Pemberian Stevoisida terhadap Reproduksi dan Perkembangan Embrio Tikus Putih. PhD Thesis. Airlangga University. Surabaya 2003.
- [8] Greenstein D. Control of oocyte meiotic maturation and fertilization. *Wormbook*. Nashville 2005. pp 1-12.
- [9] Centola GM, Anderson LD, Channing CP. Oocyte maturation inhibitor (OMI) activity in protein granulosa cells. *Gamet Res* 2005; **4**(5): 451-461. doi: 10.1002/mrd.1120040508.
- [10] Beall S, Brenner C, Segars J. Oocyte maturation failure: a syndrome of bad eggs. *Fertil Steril* 2010; **94**(7): 2507-2513. doi: 10.1016/j.fertnstert.2010.02.037.
- [11] Freour T, Masson D, Dessolle L, Allaoua D, Dejoie T, Mirallie S, et al. Ovarian reserve and *in vitro* fertilization cycles outcome according to women smoking status and stimulation regimen. *Arch Gynecol Obstet* 2012; **285**(4): 1177-1182. doi: 10.1007/s00404-011-2171-7.
- [12] Paixão LLO, Gaspar-Reis RP, Gonzales GPL, Santos AS, Santana AC, Santos RMM, et al. Cigarette smoke impairs granulosa cell proliferation and oocyte growth after exposure cessation in young Swiss mice: an experimental study. *J Ovarian Res* 2012; **5**: 25. doi: 10.1186/1757-2215-5-25.

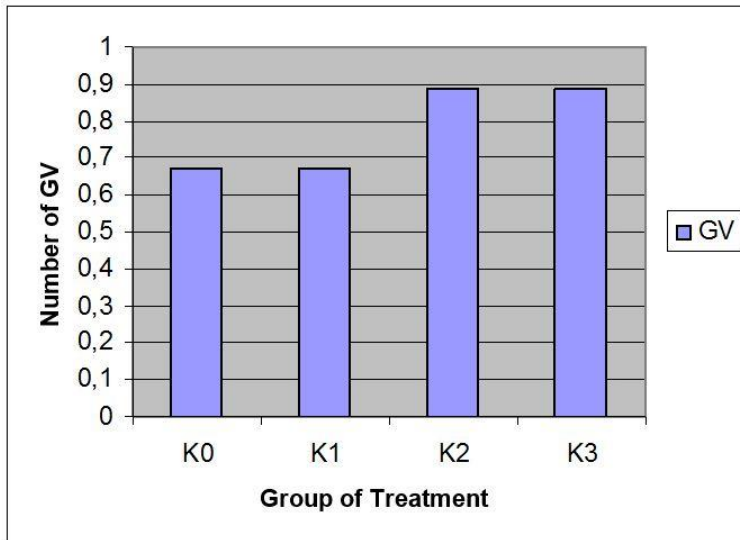
- [13]Son W-Y, Lee S-Y, Lim J-H. Fertilization, cleavage and blastocyst development according to the maturation timing of oocytes *in vitro* maturation cycles. *Hum Reprod* 2005; **20**(11): 3204-3207. doi: 10.1093/humrep/dei95.
- [14]Lim JH, West KL, Pubinstein Y, Bergel M, Postnikov YV, Bustin M. Chromosomal protein HMGN1 enhances the acetylation of lysine 14 in histone H3. *EMBO J* 2005; **24**(7): 3038-3048. doi: 10.1038/sj.emboj.7600768.
- [15]Hukkanen J, Jacob P 3rd, Benowitz NL. Metabolism and disposition kinetics of nicotine. *Pharmacol Rev* 2005; **57**(1): 79-115. doi: 10.1124/pr.57.1.3.



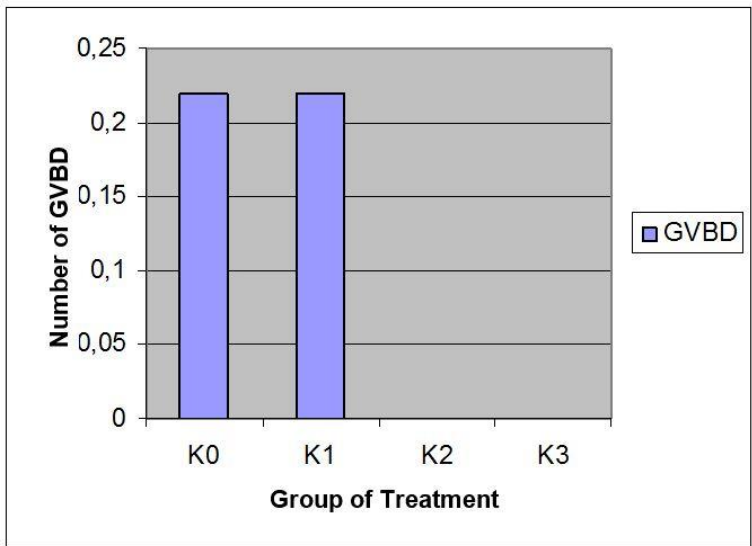


**Figure 1.** Research plan flowchart.

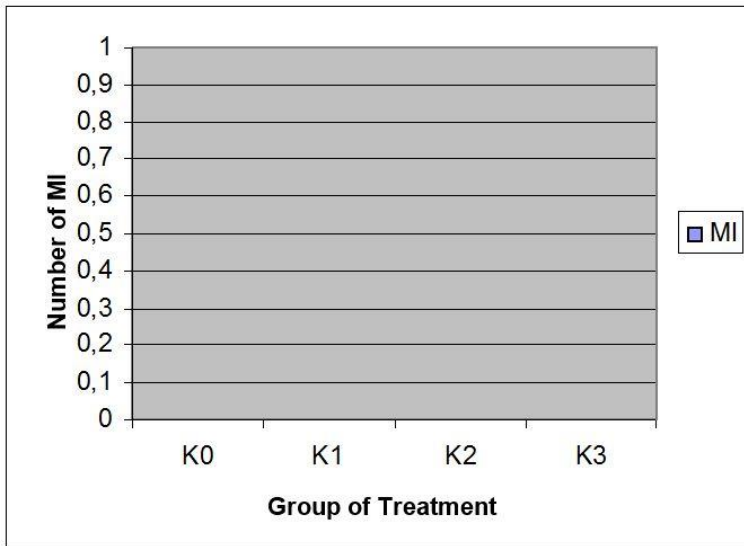
S: Sample, R: Random, K<sub>0</sub>: The control group, K<sub>1</sub>–K<sub>3</sub>: The treatment group, P<sub>0</sub>: Given nicotine using aquabidest for 7 d, Given nicotine distilled water for 7 d, P<sub>1</sub>: Given nicotine 35 mg/Kg BB for 7 d, P<sub>2</sub>: Given nicotine 52, 5 mg/kg BB for 7 d, P<sub>3</sub>: Given nicotine 70 mg/kg BB for 7 d, O<sub>1</sub>–O<sub>4</sub>: the observation result (the number of oocytes GV, GVBD, M I, and M II)



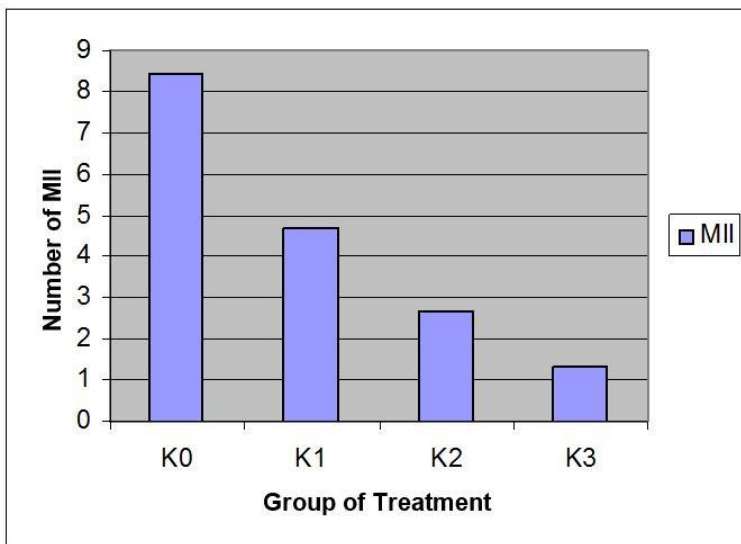
**Figure 2.** The number of GV in various groups



**Figure 3.** The number of GVBD on different groups



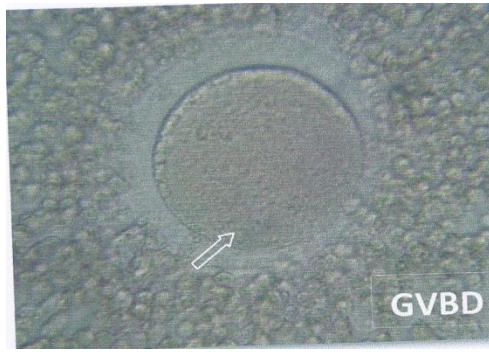
**Figure 4.** The number of M I in various groups



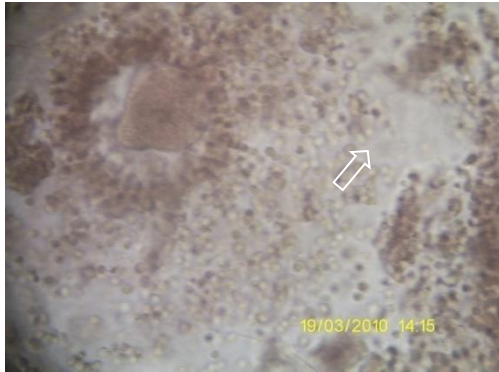
**Figure 5.** The number of M II in the various groups



a. GV



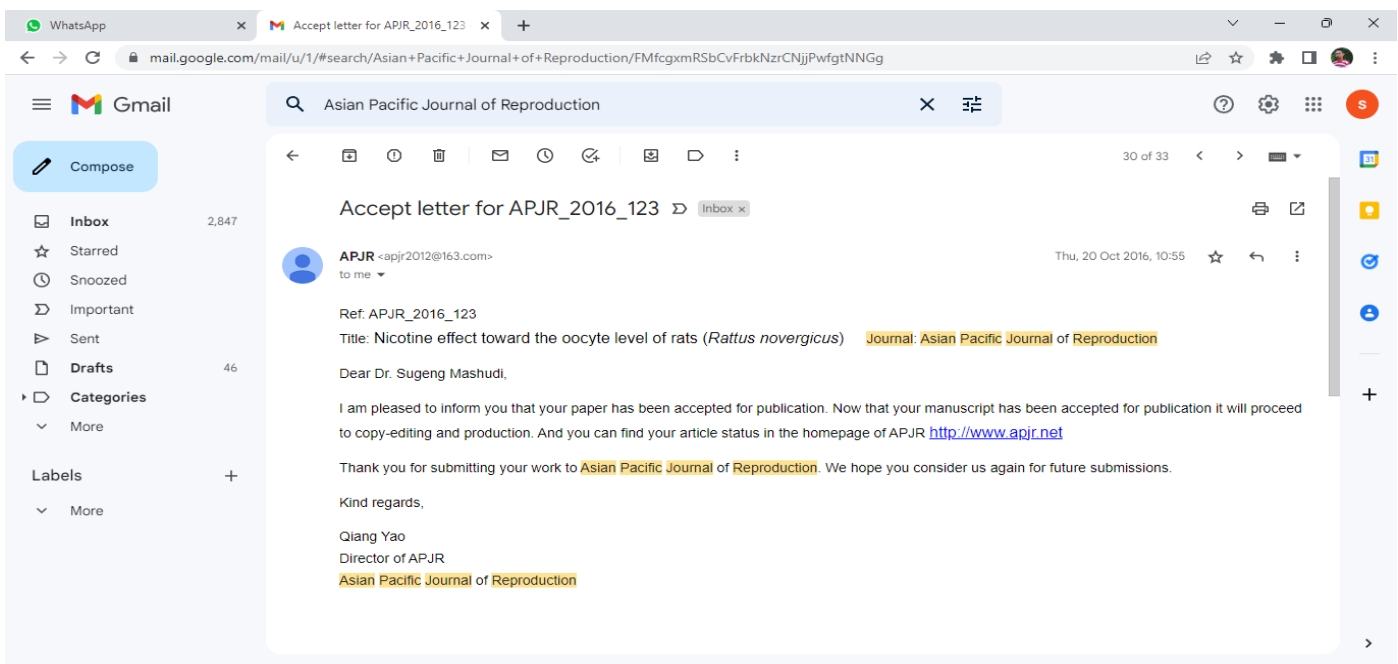
b. GVBD



c. M II There are polar body

Figure 6. Different level of maturation of oocytes

### 3. Mendapatkan LOA dari Asian Pacific Journal of reproduction 20 Oktober 2016



## 4. Revisi Final dari Asian Pacific Journal of reproduction 25 Oktober 2016

The screenshot shows an email client interface. On the left is a sidebar with folders: Compose, Inbox (2,847), Starred, Snoozed, Important, Sent, Drafts (46), Categories, and Labels. The main content area displays an email with the following text:

*This message was sent automatically. Please do not reply.*

Ref: APJR\_2016\_123\_R2  
Title: The Nicotine Effect toward the Oocyte Level of Rats (*Rattus norvegicus*)  
Journal: **Asian Pacific Journal of Reproduction**

Dear Mr. Mashudi,

Thank you for submitting your revised manuscript for consideration for publication in **Asian Pacific Journal of Reproduction**. Your revision was received in good order.

To track the status of your manuscript, please log into EVISE® [http://www.evise.com/evise/faces/pages/navigation/NavController.jspx?JRNL\\_ACR=APJR](http://www.evise.com/evise/faces/pages/navigation/NavController.jspx?JRNL_ACR=APJR) and locate the submission under the header 'My Submissions with **Journal**' on your 'My Author Tasks' view.

We appreciate your submitting your revision to this **journal**.

Kind regards,

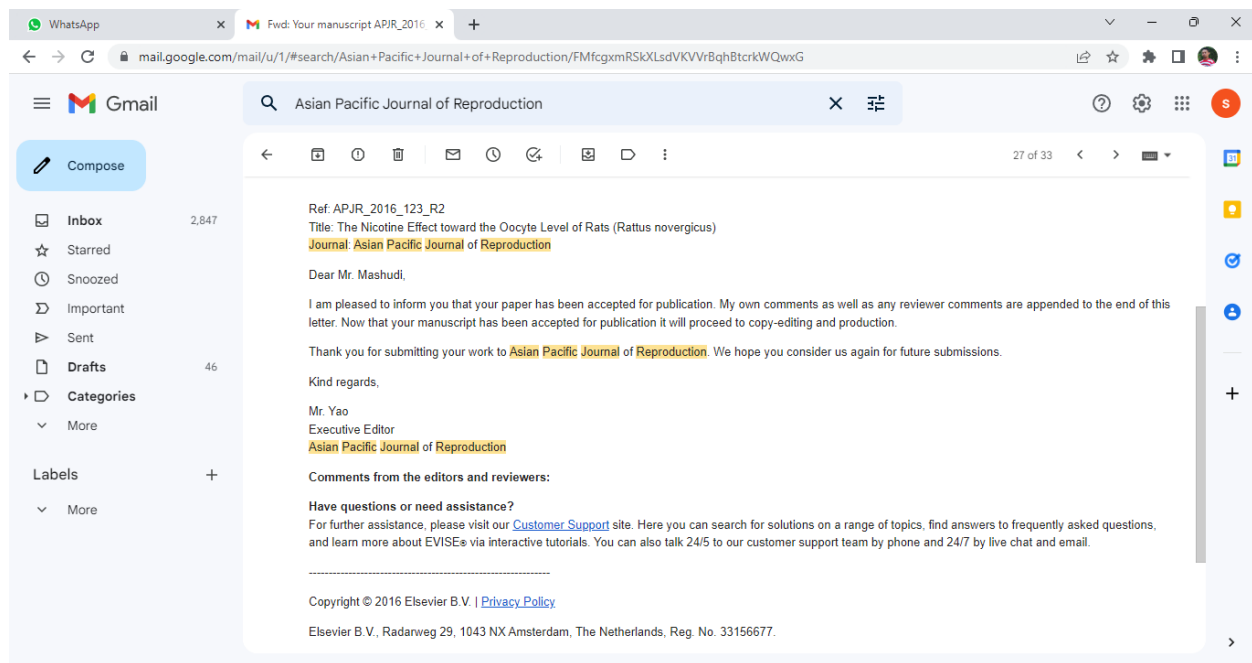
**Asian Pacific Journal of Reproduction**

**Have questions or need assistance?**  
For further assistance, please visit our [Customer Support](#) site. Here you can search for solutions on a range of topics, find answers to frequently asked questions, and learn more about EVISE® via interactive tutorials. You can also talk 24/5 to our customer support team by phone and 24/7 by live chat and email.

-----

Copyright © 2016 Elsevier B.V. | [Privacy Policy](#)  
Elsevier B.V., Radarweg 29, 1043 NX Amsterdam, The Netherlands, Reg. No. 33156677.

## 5. Accepted for Publication dari Asian Pacific Journal of reproduction 25 Oktober 2016



The screenshot shows a Gmail interface with a search bar containing "Asian Pacific Journal of Reproduction". The email content is as follows:

Ref: APJR\_2016\_123\_R2  
Title: The Nicotine Effect toward the Oocyte Level of Rats (*Rattus norvegicus*)  
Journal: [Asian Pacific Journal of Reproduction](#)

Dear Mr. Mashudi,

I am pleased to inform you that your paper has been accepted for publication. My own comments as well as any reviewer comments are appended to the end of this letter. Now that your manuscript has been accepted for publication it will proceed to copy-editing and production.

Thank you for submitting your work to [Asian Pacific Journal of Reproduction](#). We hope you consider us again for future submissions.

Kind regards,

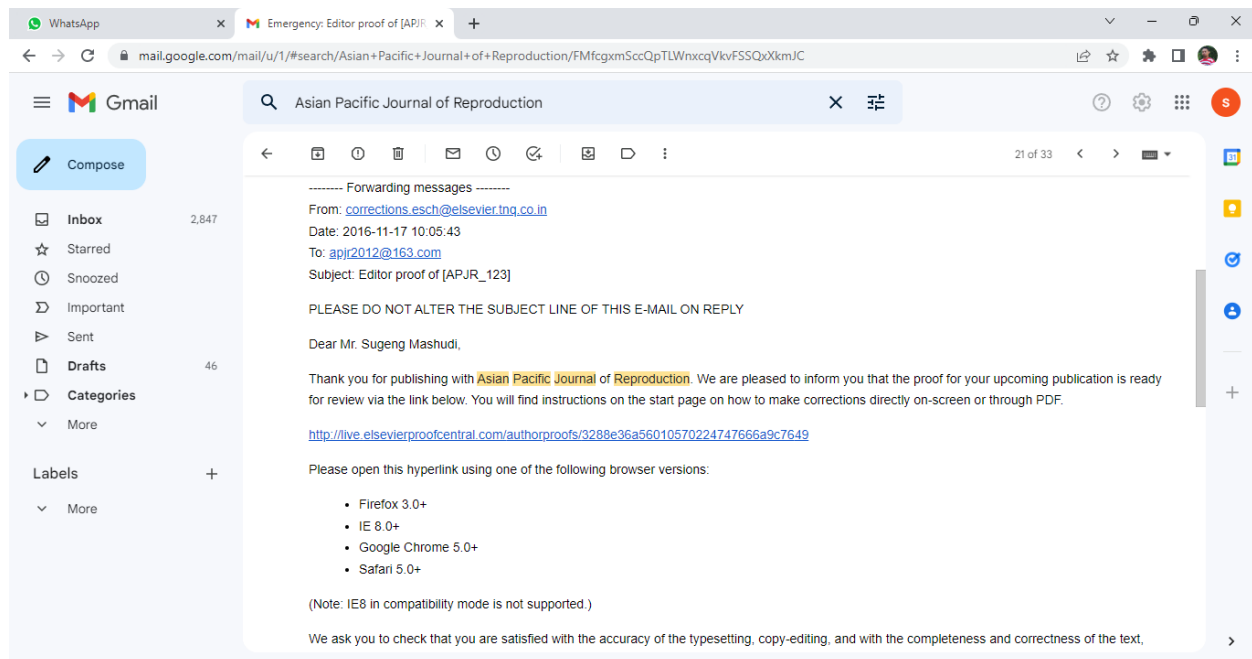
Mr. Yao  
Executive Editor  
[Asian Pacific Journal of Reproduction](#)

**Comments from the editors and reviewers:**

**Have questions or need assistance?**  
For further assistance, please visit our [Customer Support](#) site. Here you can search for solutions on a range of topics, find answers to frequently asked questions, and learn more about EVISE via interactive tutorials. You can also talk 24/5 to our customer support team by phone and 24/7 by live chat and email.

-----  
Copyright © 2016 Elsevier B.V. | [Privacy Policy](#)  
Elsevier B.V., Radanweg 29, 1043 NX Amsterdam, The Netherlands, Reg. No. 33156677.

## 6. Editor Proofreading dari Asian Pacific Journal of reproduction 17 November 2016



The screenshot shows a Gmail interface with a search bar containing "Asian Pacific Journal of Reproduction". The email content is as follows:

----- Forwarding messages -----  
From: [corrections.esch@elsevier.tng.co.in](mailto:corrections.esch@elsevier.tng.co.in)  
Date: 2016-11-17 10:05:43  
To: [apjr2012@163.com](mailto:apjr2012@163.com)  
Subject: Editor proof of [APJR\_123]

PLEASE DO NOT ALTER THE SUBJECT LINE OF THIS E-MAIL ON REPLY

Dear Mr. Sugeng Mashudi,

Thank you for publishing with **Asian Pacific Journal of Reproduction**. We are pleased to inform you that the proof for your upcoming publication is ready for review via the link below. You will find instructions on the start page on how to make corrections directly on-screen or through PDF.

<http://live.elsevierproofcentral.com/authorproofs/3288e36a56010570224747666a9c7649>

Please open this hyperlink using one of the following browser versions:

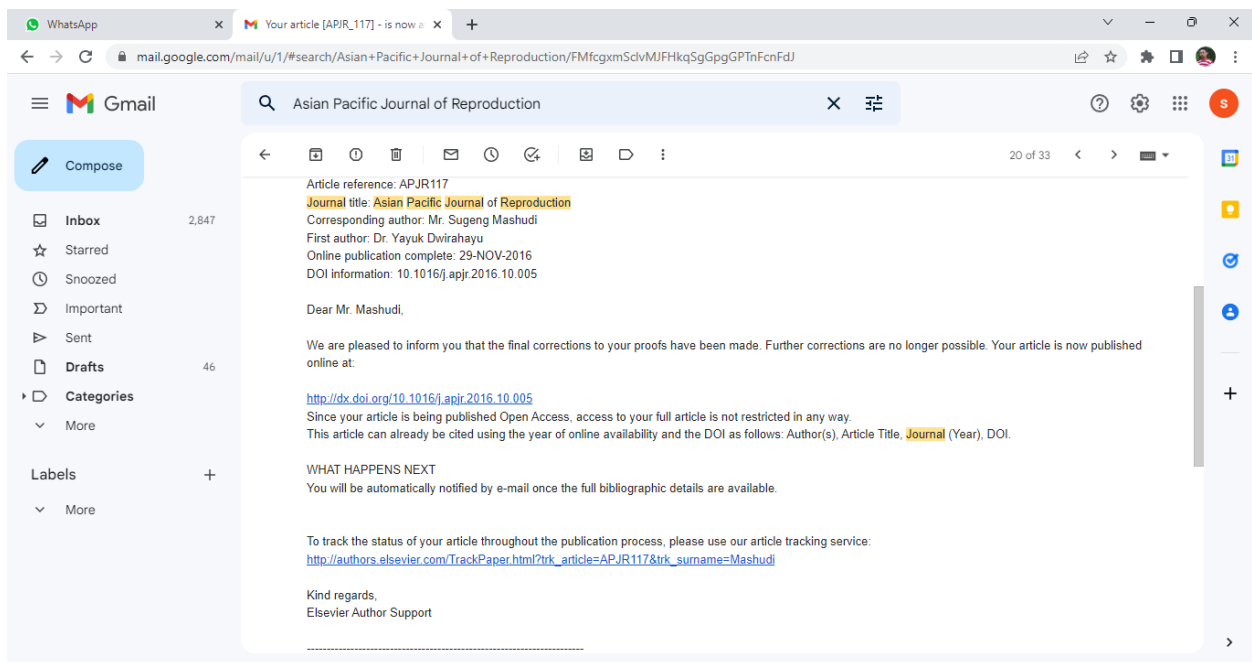
- Firefox 3.0+
- IE 8.0+
- Google Chrome 5.0+
- Safari 5.0+

(Note: IE8 in compatibility mode is not supported.)

We ask you to check that you are satisfied with the accuracy of the typesetting, copy-editing, and with the completeness and correctness of the text.



## 7. Online Publication Complete dari Asian Pacific Journal of reproduction 30 November 2016



The screenshot shows a Gmail interface with a search bar containing "Asian Pacific Journal of Reproduction". The email content is as follows:

Article reference: APJR117  
Journal title: **Asian Pacific Journal of Reproduction**  
Corresponding author: Mr. Sugeng Mashudi  
First author: Dr. Yayuk Dwirahayu  
Online publication complete: 29-NOV-2016  
DOI information: 10.1016/j.apjr.2016.10.005

Dear Mr. Mashudi,

We are pleased to inform you that the final corrections to your proofs have been made. Further corrections are no longer possible. Your article is now published online at:

<http://dx.doi.org/10.1016/j.apjr.2016.10.005>

Since your article is being published Open Access, access to your full article is not restricted in any way. This article can already be cited using the year of online availability and the DOI as follows: Author(s), Article Title, **Journal** (Year), DOI.

WHAT HAPPENS NEXT  
You will be automatically notified by e-mail once the full bibliographic details are available.

To track the status of your article throughout the publication process, please use our article tracking service:  
[http://authors.elsevier.com/TrackPaper.html?trk\\_article=APJR117&trk\\_surname=Mashudi](http://authors.elsevier.com/TrackPaper.html?trk_article=APJR117&trk_surname=Mashudi)

Kind regards,  
Elsevier Author Support

## 8. Published Online dari Asian Pacific Journal of reproduction 10 Desember 2016

The screenshot shows a Gmail interface with a search bar containing "Asian Pacific Journal of Reproduction". The email being viewed is titled "The final version of your article [APJR\_117] is now published online" and is from Elsevier. The email content includes a notice that it is system-generated, followed by bibliographic details for the article "The Nicotine Effect toward the Oocyte Level of Rats (Rattus norvegicus)".

**Subject:** The final version of your article [APJR\_117] is now published online

**From:** Elsevier - Article Status <Article\_Status@elsevier.com>  
to me, capa.journal16

10 Dec 2016, 01:15

Please note this is a system generated email from an unmanned mailbox.  
If you have any queries we really want to hear from you via our 24/7 support at <http://service.elsevier.com>

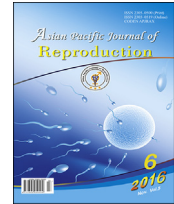
Article title: The Nicotine Effect toward the Oocyte Level of Rats (Rattus norvegicus)  
Reference: APJR117  
Journal title: **Asian Pacific Journal of Reproduction**  
Corresponding author: Mr. Sugeng Mashudi  
First author: Dr. Yayuk Dwirahayu  
Final version published online: 9-DEC-2016  
Full bibliographic details: **Asian Pacific Journal of Reproduction** 5 (2016) pp. 495-499  
DOI information: 10.1016/j.apjr.2016.10.005

Dear Mr. Mashudi,

The final version of your article with full bibliographic details is now available online at:

Contents lists available at [ScienceDirect](http://www.sciencedirect.com)

## Asian Pacific Journal of Reproduction

journal homepage: [www.apjr.net](http://www.apjr.net)Original research <http://dx.doi.org/10.1016/j.apjr.2016.10.005>Nicotine effect toward the oocyte level of rats (*Rattus novvergicus*)Yayuk Dwirahayu<sup>1</sup>, Sugeng Mashudi<sup>2\*</sup><sup>1</sup>Department of Nursing, Faculty of Health Sciences, Muhammadiyah University of Ponorogo, Ponorogo, East Java, Indonesia<sup>2</sup>Department of Midwifery, Faculty of Health Sciences, Muhammadiyah University of Ponorogo, Ponorogo, East Java, Indonesia

## ARTICLE INFO

## Article history:

Received 21 Jul 2016

Received in revised form 25 Oct 2016

Accepted 25 Oct 2016

Available online 3 Nov 2016

## Keywords:

Germinal vesicle

Germinal vesicle breakdown

Metaphase I

Metaphase II

Nicotine

## ABSTRACT

**Objective:** To discover the effect of some nicotine's doses to the maturity of rat's oocyte in reproductive age.**Methods:** This study was using an experimental design with 3 treatment groups (subcutaneous injection of nicotine 35, 52.5 and 70 mg/kgBW/d for 7 d) and 1 control group. After nicotine exposure treatment, the oocytes of rats were taken for the histological purpose to observe the oocyte's maturity grade in germinal vesicle (GV), Germinal Vesicle Breakdown (GVBD), Metaphase I (M I), or Metaphase II (M II). All of the oocytes were stained using Aceto orcein 1%. The data was analyzed based on One-Way Analysis of Variance ( $\alpha = 0.05$ ).**Results:** The significant result got further analyzed using LSD test. The result obtained that there were no significant differences of GV and GVBD oocytes in all groups. Otherwise, the result of One-Way ANOVA showed that there was significant differences of M–II oocytes in all groups. LSD test obtained that there was significant differences between control group and 3 treatment groups, and nicotine's treatment 52.5 mg/kg body weight (BW) with 35 mg/kg BW. This research obtained that the number of GV and GVBD oocytes were lower than the control group.**Conclusion:** There was no M I and M II oocytes, because nicotine treatment were less than the control group.

## 1. Introduction

Nicotine is one of the components in a cigarette that considered as addiction substance that cause smoking habit. Infertility is a determination of the existence and cause of death of the products of conception or fertility disorders. Compounds that contained in cigarette smoke consist of 90% gas and 20% different kinds of particles. The gaseous substance in a cigarette is CO, CO<sub>2</sub>, cyanide, various hydrocarbons, and organic acids [1]. Women who smoke, their reproductive system will be affected, because every cigarette contains 4000 chemicals. Chemicals particles in a cigarette are divided into 3 groups: nicotine, tar, and carbon monoxide. One of the impacts on women's reproduction is infertility [1].

Some researches that have been conducted shows that the pair of men and women who are infertile after consuming

cigarettes for more than 5 years. The cigarettes that are consumed contain 0.8–1.8 mg nicotine per cigarette; but it depends on the brand and size. One milligram of nicotine can be absorbed into the body during smoking one cigarette [2]. The same point was described by Mai *et al.* [3], he stated that the risk of infertility of active smoker women is 1.6 times more than non-smoker women [3].

Research about cigarettes that have been conducted indicates the concentration of cotinine (nicotine metabolic compounds) got in follicular fluid, which can affect the maturation of oocytes for *in vitro* fertilization [4]. The assumption is proved by the presence of oocyte maturation reduction up to 50% in women over 40 years [4]. Other study conducted to hamsters that are treated with nicotine exposure for 7 d whose folliculogenesis process can be interrupted [5]. The folliculogenesis will be issued oocyte, so it is assumed that the duration of nicotine exposure for 7 d will affect oocyte maturation process. The research of Noor *et al.* [6] toward mice by providing nicotine subcutaneous injection with dosage 5, 7.5, and 10 mg/kg have been able to influence the meiosis of oocytes by the acquisition of oocyte aneuploidy [6]. Based on Mailhess *et al.*

\*Corresponding author: Sugeng Mashudi, Department of Midwifery, Faculty of Health Sciences, Muhammadiyah University of Ponorogo, Ponorogo, East Java, Indonesia.

E-mail: [nershudi@gmail.com](mailto:nershudi@gmail.com)

Peer review under responsibility of Hainan Medical College.

(2000), the dosage of nicotine exposure of this study was set into 35, 52.5, and 70 mg/kg [6]. That dosage came from Noor *et al.* [6] toward mice dosage then converted to rats dosage by multiplied it with 7.0 [6,7].

The process of meiosis in oocytes is influenced by endogenous and exogenous factors through biochemical reactions during oocyte maturation [6]. Exogenous factor that is considerably influenced is the cigarettes, the largest of its component is nicotine. The differences between nicotine effects on oocyte maturation at age less than 40 years old and over 40 years old support this study to determine the effects of nicotine on oocyte maturation with different doses of reproductive age and consideration maturation of important oocyte in the reproductive age.

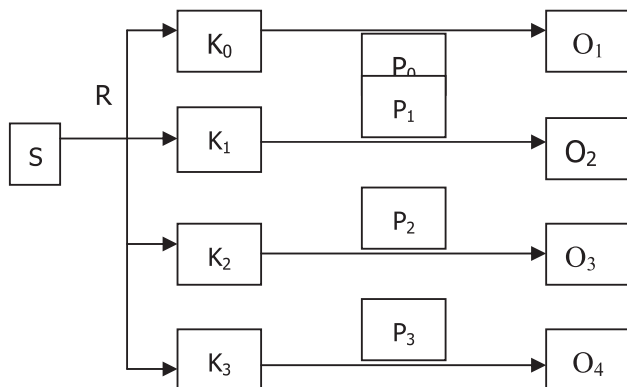
**2. Materials and methods**

This research was conducted using experimental design by providing a treatment in mice given a subcutaneous injection of nicotine with a dosage of 35, 52.5, and 70 mg/kg per day. The type of design used was a post-test only control group design with a schematic design of the study (Figure 1).

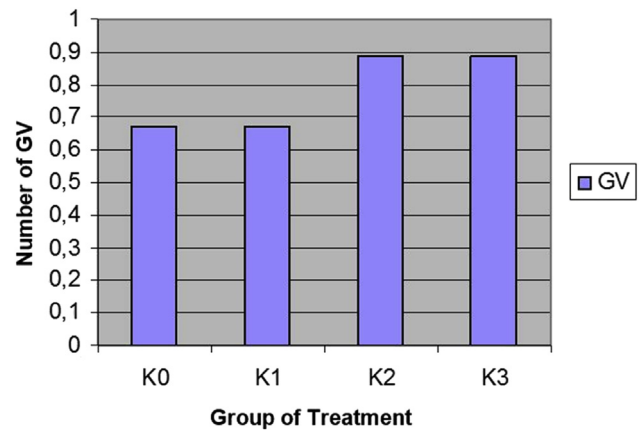
A sample of 36 rats (*Rattus norvegicus*) was divided into a control group, P1, P2 and P3. Independent variable was nicotine dosage, while the dependent variables were the level of germinal vesicle (GV), germinal vesicle breakdown (GVBD), metaphase I (M I), or metaphase II (M II). After nicotine exposure treatment, the oocytes of rats were taken for the histological purpose to observe the oocyte's maturity grade in GV, GVBD, M I and M II. All of the oocytes were stained using Aceto orcein 1%. The data was analyzed based on One-Way Analysis of Variance (ANOVA) ( $\alpha = 0.05$ ). GV and GVBD oocyte was tested using Kruskal-Wallis comparison test because the data were not normally distributed, meanwhile, the data of M II oocyte were normally distributed. Otherwise, M I data could not be analyzed because it has zero data. The significant result got further analyzed using LSD test.

**3. Results**

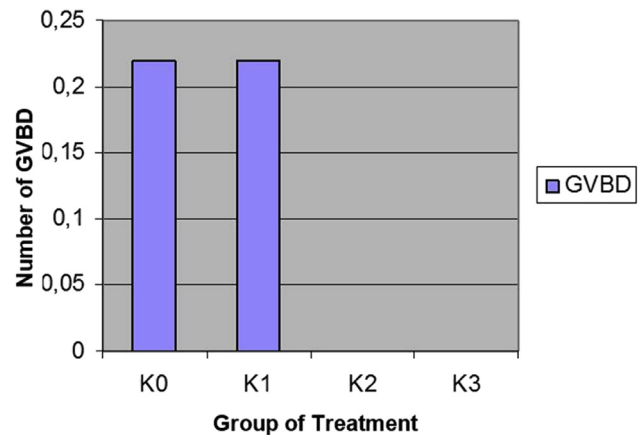
This study provided nicotine exposure in rats (*Rattus norvegicus*). The group consisted of negative control treatment (P0) for the control group (K0) as the comparison result, P1



**Figure 1.** Research plan flowchart. S: Sample, R: Random, K<sub>0</sub>: The control group, K<sub>1</sub>–K<sub>3</sub>: The treatment group, P<sub>0</sub>: Given nicotine using aquabidest for 7 d, Given nicotine distilled water for 7 d, P<sub>1</sub>: Given nicotine 35 mg/kg BB for 7 d, P<sub>2</sub>: Given nicotine 52, 5 mg/kg BB for 7 d, P<sub>3</sub>: Given nicotine 70 mg/kg BB for 7 d, O<sub>1</sub>–O<sub>4</sub>: the observation result (the number of oocytes GV, GVBD, M I, and M II).



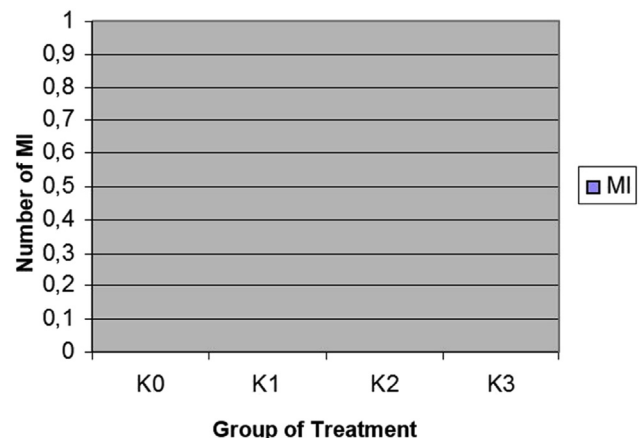
**Figure 2.** The number of GV in various groups.



**Figure 3.** The number of GVBD on different groups.

(nicotine 35 mg/kg) for K1, P2 (52.5 mg/kg) for K2, and P3 (70 mg/kg) for K3 (Figures 2–6).

Figure 2 shows that the greater the dose of nicotine makes the increasing number of GV. It shows the number of immature oocytes is also increased. Figure 3 shows that GVBD does not describe a similar pattern to GV. K0 and K1 show the same results but K2 and K3 do not produce data GVBD. Figure 4 shows that there is not found oocytes in the phase of M I. Figure 5 shows that the greater the nicotine dose given to the rats, the less number of M II oocytes produced. This illustrates that the decrease of mature oocytes due to nicotine exposure. The description of oocytes at different maturation levels obtained in this study can be seen in Figure 6. The level of maturation that found only GV, GVBD, and M II.



**Figure 4.** The number of M I in various groups.

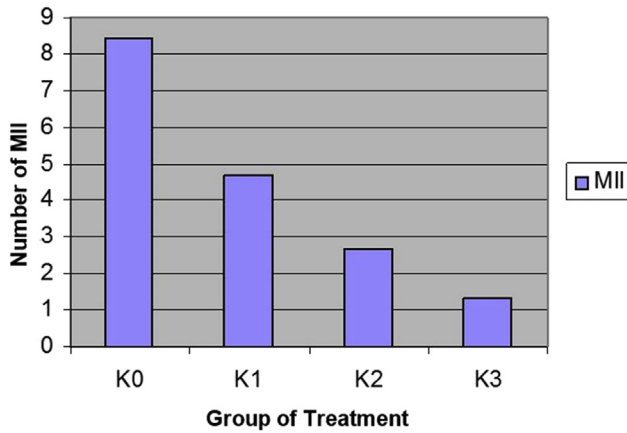


Figure 5. The number of M II in the various groups.

These nonstandard results probably caused by the deviation standard of data that was too wide and less specific, therefore, the small difference between the data will not create a significant difference. The SD value in this study was high as a consequence of trouble shooting during research method. Not all rats ovum is taken for the histopathological observation that caused the data varies from zero to the highest number of ova which was made the data have high SD value.

These results indicated that the impact of nicotine exposure toward oocyte maturation has not been able to suppress the level of GV/GVBD. The factors that might be influenced were the number of experimental animals, the dose, and duration of nicotine exposure. In this study, the limited rats number used as the experimental animal has a weakness, if ovum were unavailable in one rat (zero) it would affect the whole data. Therefore,

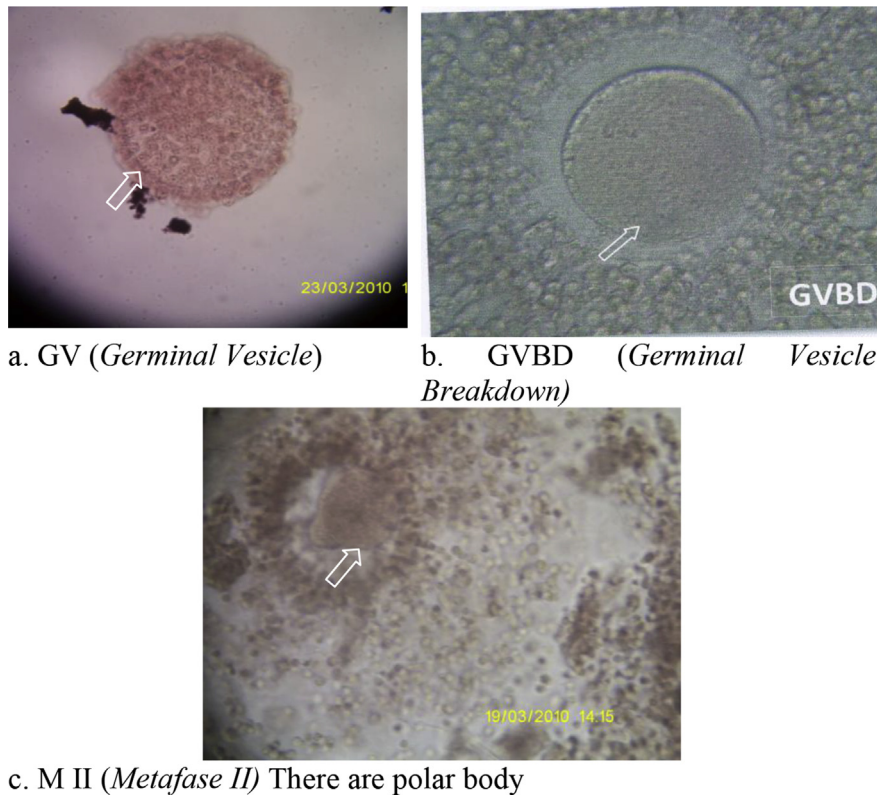


Figure 6. Different level of maturation of oocytes.

Oocytes amount in M II maturity is followed by BNT test to determine a treatment group was significantly different. BNT test of the maturation of M II showed that comparison of all groups are significant different, except between P2 and P3.

#### 4. Discussion

Oocytes maturity after GV is GVBD. The oocyte maturation process, GVBD phase, is begun because there is a response to hormone stimulus which is started by the outbreak of the core wall or GVBD. With the onset of GVBD, chromosomes condense into a compact form. The centrosome (a special area in the form of cytoplasm that solidifies) divide the two centrioles that look like cylinder shape. This cylinder shape moves apart and forms the spindle for cell proliferation purpose [8].

further studies need more rats number for better data obtained.

The nicotine exposure dosage determination was based on the study conducted by Noor *et al.* [6] which provides exposure to nicotine in mice oocytes. Furthermore, the nicotine mice dosage was had been converted to rats dose. The previous study observed the 4th level of maturation, while Noor *et al.* [6] observed the meiosis process occurred in ovum at M II phase.

In this study GV and GVB were not significantly different, and it was supported by a similar study conducted by Jennings *et al.* [4] that also provides nicotine exposure toward mice ovum. The results prove that nicotine does not affect the level of maturation to GV/GVBD, but induce abnormal spindle and chromosomes of the oocyte maturation process. The exposure duration used in this study was 7 d that

according to research conducted by Bordel *et al.* [5], which performed nicotine exposure for 7 d toward hamsters to observe folliculogenesis [5]. The previous studies were similar but they have different research purposes that make result obtained on GV and GVBD were different significantly.

The process of maturation after GV and GVBD is M I. This study obtained that all M I data were zero, indicated that there were not metaphase I process in all experimental animals. That was probably caused by a rapid process for M I before it turned into M II process and its growth stalled in the secondary oocyte [9] M I arose after GVBD process, where the nuclear membrane was folded and pores disappeared. The rest of the nuclear membrane disappeared quickly. Nuclei also disappear quickly after it contacts with the cytoplasm [9]. M I was not found in this study, the same result was also obtained by Noor *et al.* [6] who examined the ovum maturation as a result of nicotine exposure found out that all ovum were had already being in the M II process. The rapid change of GVBD to M II is allegedly being a reason for the absence of M I in this study.

The last phase is the M II that occurred after the M I. The One-Way ANOVA test result obtained that there were significant differences among all groups. This shows that nicotine affects the maturation of the ovum by reducing the number of M II in nicotine-exposed rats. The little number of M II oocytes indicated that the number of mature oocytes was insignificant due to the number of M II oocytes show that they were already mature. Oocytes which have been developed that are already mature when they were taken from the follicle will have complete meiosis process after reaching metaphase II [10]. The mature oocytes number of nicotine-exposed rats group is low because of increased nicotine exposure is associated with estradiol reduction that followed by a decrease of ovarian stimulation and the number of oocytes [11].

Nicotine is an oxide compound that can increase oxidative stress in the body. Oxidative stress that occurs in follicular fluid thus causing follicular granulosa cell apoptosis and disrupt the folliculogenesis process makes the follicles shrink [5,12]. The size of the follicle affects the development of oocyte. Noor *et al.*, [6] mentioned that nicotine can affect oocyte maturation process. Furthermore, the oocyte ability to complete meiosis and maturation depends on the size of the follicle. The number of mature oocytes from small follicles less than mature oocytes from large follicles, thus the presence of nicotine decrease the number of mature oocytes because it affected the follicles size [13,14].

The BNT test result shows that there was a significant difference between the control group and the treatment group. This means the group which was not treated with nicotine produced mature oocytes. Otherwise, the group treated with nicotine in any dose will inhibit oocyte maturation. The dosage differences showed that only doses in groups P2 and P3 that were not significantly different, but other groups were significantly different. This indicated that low dosage of nicotine (35 mg/kg body weight) can disturb the maturation of rats ovum, the same result was obtained by other higher dosages. Otherwise, the intermediate dose (52.5 mg/kg) and high dose (70 mg/kg) obtained they were not significantly different toward oocyte process disruption. It indicated that intermediate and high doses performed the same effect in this study. The dose that may be decreased the number of M II in this study was started from 35 mg/kg body weight of rats (*Rattus norvegicus*).

The converting dose from rats to human is multiplied by 56.0 [7]. The nicotine dose that assumed to reduce human oocytes during M II process is 1.960 mg or 1.96 g. During smoking, the human body can absorb nicotine ranged from 11.5 mg, thus it is assumed that mature oocytes of women will significantly decrease after exposed for about 1960 cigarettes, either the woman is an active or passive smoker. The number of cigarettes is still influenced by the volume of smoke and air inhaled, surround air condition, and the intensity of smoking [15].

We conclude that nicotine exposure doses from 35, 52.5, and 70 mg/kg did not affect the maturation of oocytes process either at GV stage nor GVBD. M I oocytes phase was not found in this study (zero). Nicotine exposure in all doses could decrease the number of oocytes at M II phase. Furthermore, there is needed further research which can conduct a larger number of dose and exposure duration to obtain the better results.

### Conflict of interest statement

The authors declare that they have no conflict of interest.

### Acknowledgement

The authors thank to the Muhammadiyah University of Ponorogo for facilitating this research.

### References

- [1] Schardein JL. *Chemically induced birth defect*. New York: Marcel Dekker Inc; 2005, p. 764-768.
- [2] Fims S, Cruzat VF, Keane KN, Joesbury KA, Lee AH, Newsholme P, et al. The effect of cigarette smoking, alcohol consumption and fruit and vegetable consumption on IVF outcomes: a review and presentation of original data. *Reprod Biol Endocrinol* 2015; **13**: 134.
- [3] Mai Z, Lei M, Yu B, Du H, Liu J. The effects of cigarette smoke extract on ovulation, oocyte morphology and ovarian gene expression in mice. *PLoS ONE* 2014; **9**(4): e95945.
- [4] Jennings PC, Merriman JA, Beckett EL, Hansbro PM, Jones KT. Increased zona pellucida thickness and meiotic spindle disruption in oocytes from cigarette smoking mice. *Hum Reprod* 2011; **26**(4): 878-884.
- [5] Bordel R, Laschke MW, Menger MD, Volmar B. Nicotine does not effect vascularization but inhibit growth of freely transplanted ovarian follicles by inducing granulosa cell apoptosis. *Hum Reprod* 2006; **21**(3): 610-616.
- [6] Noor MS, Bahkriansyah HM, Widjiati W, Santoso B. Nicotine supplementation blocks oocyte maturation in *Rattus norvegicus*. *Univ Med* 2013; **32**(2): 92-98.
- [7] Kusumawati D. *Pengaruh Pemberian Stevoisida terhadap Reproduksi dan Perkembangan Embrio Tikus Putih*. PhD Thesis. Surabaya: Airlangga University; 2003.
- [8] Greenstein D. *Control of oocyte meiotic maturation and fertilization*. Nashville: Wormbook; 2005, p. 1-12.
- [9] Centola GM, Anderson LD, Channing CP. Oocyte maturation inhibitor (OMI) activity in protein granulosa cells. *Gamet Res* 2005; **4**(5): 451-461.
- [10] Beall S, Brenner C, Segars J. Oocyte maturation failure: a syndrome of bad eggs. *Fertil Steril* 2010; **94**(7): 2507-2513.
- [11] Freour T, Masson D, Dessolle L, Allaoua D, Dejoie T, Mirallie S, et al. Ovarian reserve and *in vitro* fertilization cycles outcome according to women smoking status and stimulation regimen. *Arch Gynecol Obstet* 2012; **285**(4): 1177-1182.

- [12] Paixão LLO, Gaspar-Reis RP, Gonzales GPL, Santos AS, Santana AC, Santos RMM, et al. Cigarette smoke impairs granulosa cell proliferation and oocyte growth after exposure cessation in young Swiss mice: an experimental study. *J Ovarian Res* 2012; **5**: 25.
- [13] Son W-Y, Lee S-Y, Lim J-H. Fertilization, cleavage and blastocyst development according to the maturation timing of oocytes *in vitro* maturation cycles. *Hum Reprod* 2005; **20**(11): 3204-3207.
- [14] Lim JH, West KL, Pubinsein Y, Bergel M, Postnikov YV, Bustin M. Chromosomal protein HMGN1 enhances the acetylation of lysine 14 in histone H3. *EMBO J* 2005; **24**(7): 3038-3048.
- [15] Hukkanen J, Jacob P 3rd, Benowitz NL. Metabolism and disposition kinetics of nicotine. *Pharmacol Rev* 2005; **57**(1): 79-115.